



ANPR Camera

Frequently Asked Questions

Legal Information

About this Document

- This Document includes instructions for using and managing the Product. Pictures, charts, images and all other information hereinafter are for description and explanation only.
- The information contained in the Document is subject to change, without notice, due to firmware updates or other reasons. Please find the latest version of the Document at the Hikvision website (<https://www.hikvision.com>). Unless otherwise agreed, Hangzhou Hikvision Digital Technology Co., Ltd. or its affiliates (hereinafter referred to as "Hikvision") makes no warranties, express or implied.
- Please use the Document with the guidance and assistance of professionals trained in supporting the Product.

About this Product

- This product can only enjoy the after-sales service support in the country or region where the purchase is made.
- If the product you choose is a video product, please scan the following QR code to obtain the "Initiatives on the Use of Video Products", and read it carefully.



Acknowledgment of Intellectual Property Rights

- Hikvision owns the copyrights and/or patents related to the technology embodied in the Products described in this Document, which may include licenses obtained from third parties.
- Any part of the Document, including text, pictures, graphics, etc., belongs to Hikvision. No part of this Document may be excerpted, copied, translated, or modified in whole or in part by any means without written permission.
- **HIKVISION** and other Hikvision's trademarks and logos are the properties of Hikvision in various jurisdictions.
- Other trademarks and logos mentioned are the properties of their respective owners.

LEGAL DISCLAIMER

- TO THE MAXIMUM EXTENT PERMITTED BY APPLICABLE LAW, THIS DOCUMENT AND THE PRODUCT DESCRIBED, WITH ITS HARDWARE, SOFTWARE AND FIRMWARE, ARE PROVIDED "AS IS" AND "WITH ALL FAULTS AND ERRORS". HIKVISION MAKES NO WARRANTIES, EXPRESS OR

ANPR Camera Frequently Asked Questions

IMPLIED, INCLUDING WITHOUT LIMITATION, MERCHANTABILITY, SATISFACTORY QUALITY, OR FITNESS FOR A PARTICULAR PURPOSE. THE USE OF THE PRODUCT BY YOU IS AT YOUR OWN RISK. IN NO EVENT WILL HIKVISION BE LIABLE TO YOU FOR ANY SPECIAL, CONSEQUENTIAL, INCIDENTAL, OR INDIRECT DAMAGES, INCLUDING, AMONG OTHERS, DAMAGES FOR LOSS OF BUSINESS PROFITS, BUSINESS INTERRUPTION, OR LOSS OF DATA, CORRUPTION OF SYSTEMS, OR LOSS OF DOCUMENTATION, WHETHER BASED ON BREACH OF CONTRACT, TORT (INCLUDING NEGLIGENCE), PRODUCT LIABILITY, OR OTHERWISE, IN CONNECTION WITH THE USE OF THE PRODUCT, EVEN IF HIKVISION HAS BEEN ADVISED OF THE POSSIBILITY OF SUCH DAMAGES OR LOSS.

- YOU ACKNOWLEDGE THAT THE NATURE OF THE INTERNET PROVIDES FOR INHERENT SECURITY RISKS, AND HIKVISION SHALL NOT TAKE ANY RESPONSIBILITIES FOR ABNORMAL OPERATION, PRIVACY LEAKAGE OR OTHER DAMAGES RESULTING FROM CYBER-ATTACK, HACKER ATTACK, VIRUS INFECTION, OR OTHER INTERNET SECURITY RISKS; HOWEVER, HIKVISION WILL PROVIDE TIMELY TECHNICAL SUPPORT IF REQUIRED.
- YOU AGREE TO USE THIS PRODUCT IN COMPLIANCE WITH ALL APPLICABLE LAWS, AND YOU ARE SOLELY RESPONSIBLE FOR ENSURING THAT YOUR USE CONFORMS TO THE APPLICABLE LAW. ESPECIALLY, YOU ARE RESPONSIBLE, FOR USING THIS PRODUCT IN A MANNER THAT DOES NOT INFRINGE ON THE RIGHTS OF THIRD PARTIES, INCLUDING WITHOUT LIMITATION, RIGHTS OF PUBLICITY, INTELLECTUAL PROPERTY RIGHTS, OR DATA PROTECTION AND OTHER PRIVACY RIGHTS. YOU SHALL NOT USE THIS PRODUCT FOR ANY PROHIBITED END-USES, INCLUDING THE DEVELOPMENT OR PRODUCTION OF WEAPONS OF MASS DESTRUCTION, THE DEVELOPMENT OR PRODUCTION OF CHEMICAL OR BIOLOGICAL WEAPONS, ANY ACTIVITIES IN THE CONTEXT RELATED TO ANY NUCLEAR EXPLOSIVE OR UNSAFE NUCLEAR FUEL-CYCLE, OR IN SUPPORT OF HUMAN RIGHTS ABUSES.
- IN THE EVENT OF ANY CONFLICTS BETWEEN THIS DOCUMENT AND THE APPLICABLE LAW, THE LATTER PREVAILS.

© Hangzhou Hikvision Digital Technology Co., Ltd. All rights reserved.

Contents

Chapter 1 Installation Requirements	1
1.1 Installation Recommendation	1
1.2 Entrance/Exit Scenario	3
1.3 City Street Scenario	5
Chapter 2 Configuration	8
2.1 How to Configure Image Parameters to Ensure Clear Imaging for the ANPR Camera?	8
2.2 How to Configure Road Traffic Function?	10
2.3 How to Configure Wiegand?	16
2.4 How to Filter the Duplicated License Plates?	16
2.5 Why Cannot I Import the Blocklist and Allowlist File?	17
2.6 Why Does Not My Completed Linkage Configuration Take Effect?	19
2.7 What Are the Imaging Requirements for License Plate Captures?	20
Chapter 3 License Plate Recognition	22
3.1 What If the License Plate Recognition Error Occurs?	22
3.2 Why Is the Background Dark in the Captured Picture?	23
3.3 Why Is the Captured Picture Incomplete but the Recognized Plate Number Correct?	24
Chapter 4 Scenario Cases	26
4.1 Inappropriate Scenarios	26
4.1.1 Large Deflection Angle	26
4.1.2 Open Scene	26
4.1.3 Far from the Target	26
4.1.4 Far Behind the Barrier	26
4.2 Not Recommended Scenarios	27
4.2.1 The Vehicle Body Is Not Fully Exposed	27
4.2.2 Uncontrollable Driving Directions	27

Chapter 1 Installation Requirements

1.1 Installation Recommendation

This part introduces the recommended installation position, height, and angle of ANPR (Automatic Number Plate Recognition) cameras in actual scenarios. For specific installation operations, refer to the Quick Start Guide of the camera for details.

The installation scenarios of ANPR cameras are usually the entrance/exit and city street, and you can choose the right location for installation according to the camera and the actual scenario. The appropriate installation may help improve the license plate recognition of the camera.

- For entrance/exit scenarios, refer to ***Entrance/Exit Scenario*** for details.
- For city street scenarios, refer to ***City Street Scenario*** for details.

Refer to the following installation diagram and table to install the camera.



The installation diagram is for reference only. The actual scenario and appearance may vary.

ANPR Camera Frequently Asked Questions

Entrance/Exit

Horizontal Angle

The view angle of the camera should be within 30° to the path of movement.

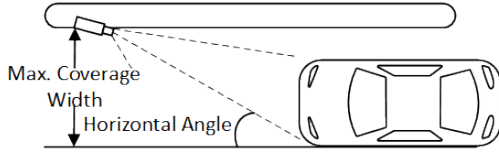

Vertical Angle

The angle between the lens direction and the horizontal should be less than 30°.

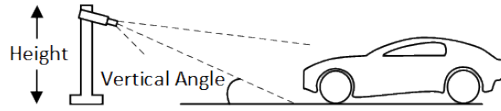

Side of the Lane

City Street

Horizontal Angle

The horizontal angle should not exceed 30°.

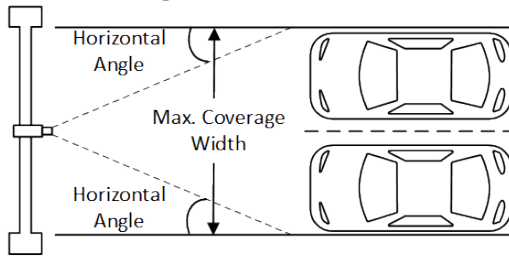

Middle of the Road

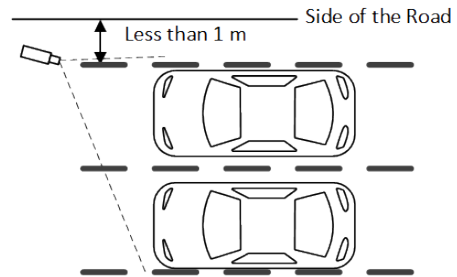

Side of the Gantry

Vertical Angle

The angle between the lens direction and the horizontal should be less than 30°.

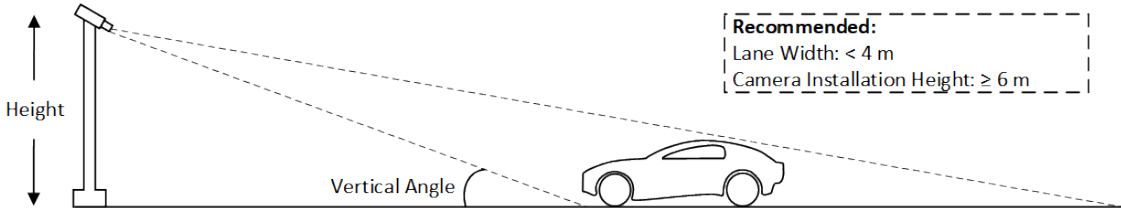

Recommended:
Lane Width: < 4 m
Camera Installation Height: ≥ 6 m

Figure 1-1 Installation Diagram

Table 1-1 ANPR Camera Installation Data Table

Camera Position	Lens	Height (m)	Suggested Vertical Angle	Suggested Trigger Distance (m)	Max. Coverage Width	Max. Horizontal Angle	Vertical Angle Range	Capture Range (m)
Side of the Lane	2.8 to 12 mm	1.5	20°	4	4.5	30°	15° to 30°	2.5 to 5.5

ANPR Camera Frequently Asked Questions

Side of the Lane	2.8 to 12 mm	2	20°	5.5	4.5	30°	15° to 30°	3.5 to 7.5
Side of the Lane	2.8 to 12 mm	2.5	20°	6.5	4.5	30°	15° to 30°	4.5 to 9
Side of the Lane	8 to 32 mm	3	20°	8	6	30°	15° to 30°	5 to 11
Side of the Lane	8 to 32 mm	4	20°	11	6	30°	15° to 30°	6 to 14
Side of the Lane	8 to 32 mm	5	20°	13.5	6	30°	15° to 30°	8.5 to 18
Side of the Lane	8 to 32 mm	6	20°	16.5	6	30°	15° to 30°	10 to 22
Middle of the Road	8 to 32 mm	3	20°	8	12	30°	15° to 30°	5 to 11
Middle of the Road	8 to 32 mm	4	20°	11	12	30°	15° to 30°	6 to 14
Middle of the Road	8 to 32 mm	5	20°	13.5	12	30°	15° to 30°	8.5 to 18
Middle of the Road	8 to 32 mm	6	20°	16.5	12	30°	15° to 30°	10 to 22

1.2 Entrance/Exit Scenario

This part introduces the key points and requirements for installation in the entrance/exit scenarios.

ANPR Camera Frequently Asked Questions

1. Camera installation location: The camera cannot be installed behind the barrier. It must be installed in front of or parallel to the barrier.
2. Camera installation height and angle: The height is recommended to be about 1.6 to 2 m. The depression angle should not be too small to avoid direct light from the head light, and should be less than 30°. We recommend that the camera be installed at a depression angle of 15° to 20°.
3. Lane width: The lane width should be less than 3.5 m.

Horizontal Angle

The view angle of the camera should be within 30° to the path of movement.

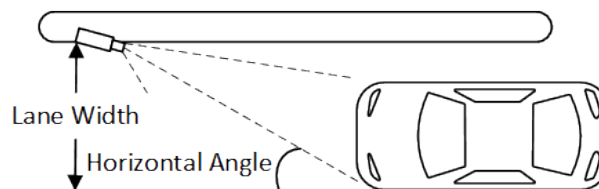

Vertical Angle

The angle between the lens direction and the horizontal should be less than 30°.

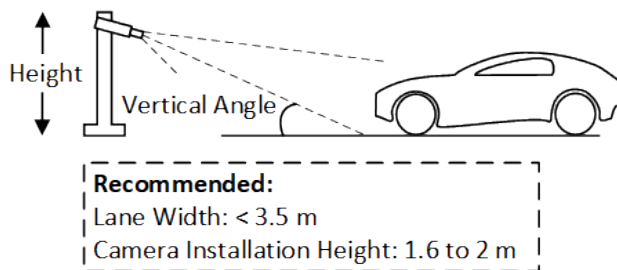

Figure 1-2 Entrance/Exit Installation Diagram

Key Points of Standard Installation at the Entrance and Exit

1. The installation height is 1.6 m to 2 m (not too high or too low).
2. The deflection angle of the camera is about 30°.
3. Only 1 lane can be configured, and the lane width should be less than 3.5 m.

Requirements of Standard Installation at the Entrance and Exit

1. The imaging is normal, and the license plate is clear and recognizable.
2. The angle is normal, the vehicle queue is exposed one by one, and there is no driving route that leads to vehicle occlusion and intersection problems
3. The field of view is normal, and the vehicle is completely exposed, which does not affect the model and brand effect of the vehicle.
4. The scale is normal, and the license plate character height needs to be greater than 16 pixels within the capture range.

1.3 City Street Scenario

This part introduces the key points and requirements for installation in the city street scenarios.

1. When two lanes are supported, the camera needs to be installed in the middle of the gantry. However, when the speed exceeds 60 km/h, the lane line should be configured as a single lane.

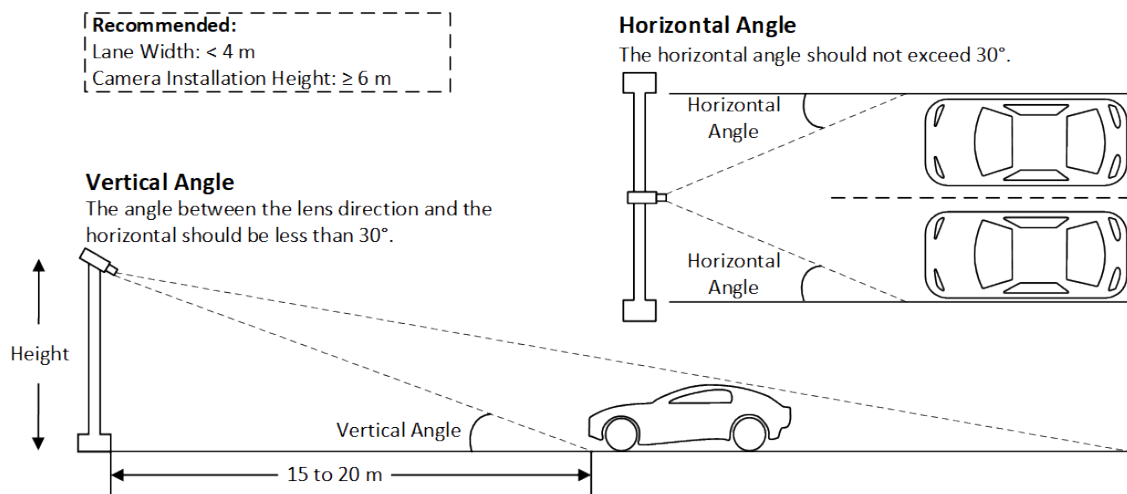

Figure 1-3 City Street Installation Diagram (In the Middle of the Gantry)

2. The horizontal angle should not exceed 30° .
3. Camera installation height and angle: The height should be more than 6 m. The horizontal distance between the camera and vehicle should be 15 to 20 m, and the vertical angle should not exceed 30° .
4. Lane width: Single lane width should be less than 4 m.
5. The camera can also be installed on the side of the gantry. It is necessary to ensure that the camera field of view is not blocked. The camera installation site shall not be more than 1 m away from the road.

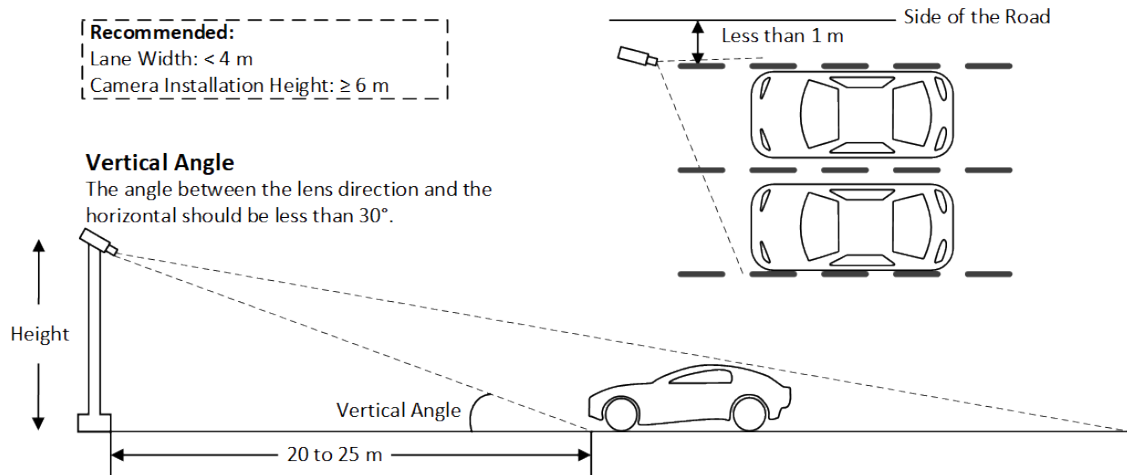

Figure 1-4 City Street Installation Diagram (On the Side of the Gantry)

Key Points of Standard Installation in the Middle of the Gantry

1. Installation height ≥ 6 m.
2. The camera pitch angle is about 30° .
3. The vision is wide, and the body of large vehicles should be completely exposed.

Requirements of Standard Installation in the Middle of the Gantry

1. The imaging is normal, and the license plate is clear and recognizable.
2. The angle is normal, the vehicle attitude is correct, and the vehicle brand and model can be tested.
3. The field of view is normal, and the vehicle is completely exposed, which does not affect the model and brand effect of the vehicle.
4. The scale is normal, and the license plate character height needs to be greater than 16 pixels within the capture range.

Key Points of Standard Installation on the Side of the Gantry

1. Installation height > 6 m.
2. The camera depression angle is about 30° .
3. Camera deflection angle $< 30^\circ$.
4. The body of large vehicles should be completely exposed.

Requirements of Standard Installation on the Side of the Gantry

1. The imaging is normal, and the license plate is clear and recognizable.
2. The angle is normal, the camera installation height is greater than 6 m, and the inclination angle is less than 30° .

ANPR Camera Frequently Asked Questions

3. The field of view is normal, and the vehicle is completely exposed, which does not affect the model and brand effect of the vehicle.
4. The scale is normal, and the license plate character height needs to be greater than 16 pixels within the capture range.

Chapter 2 Configuration

2.1 How to Configure Image Parameters to Ensure Clear Imaging for the ANPR Camera?

Question

How to configure image parameters to ensure clear imaging for the ANPR camera?

Answer

To ensure a clear image quality, you can configure the following parameters according to the instructions. Complete other settings based on actual conditions.

Day/Night Switch

Day/Night Switch function can provide color images and black/white images in the day and night modes.

Go to **Image** → **Display Settings** → **Day/Night Switch** and set **Day/Night Switch** as **Triggered by Video**.

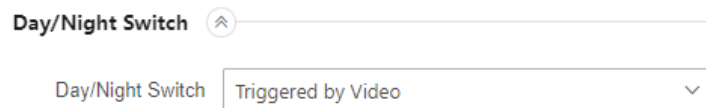

Figure 2-1 Set Day/Night Switch as Triggered by Video

Gain

Go to **Image** → **Display Settings** → **Exposure Settings** and set **Gain** as **20**.

Note

Gain is not supported when you select **Auto** for **Day/Night Switch**.

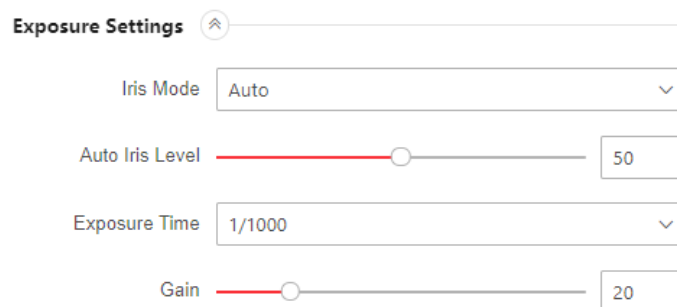

Figure 2-2 Set Gain as 20

Exposure Time

Go to **Image** → **Display Settings** → **Exposure Settings** and set **Exposure Time** according to the vehicle speed:

Table 2-1 Recommended Settings for Exposure Time

Vehicle Speed	Exposure Time
< 30 km/h	1/150 to 1/200
30 to 60 km/h	1/250 to 1/500
> 60 km/h	1/1000

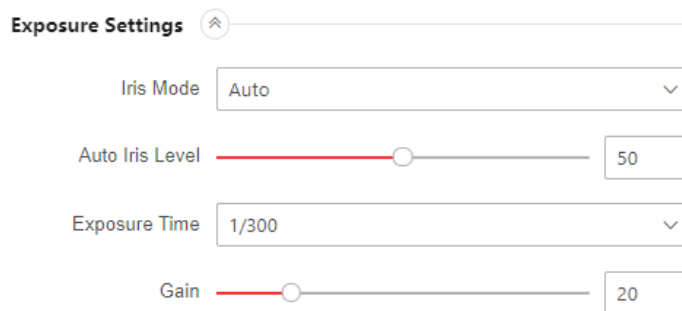

Figure 2-3 Set Exposure Time According to Vehicle Speed

Focus Mode

Go to **Image** → **Display Settings** → **Focus** and set **Focus Mode** as **Semi-Auto**.

The device focuses once after the PTZ and lens zooming. If the image is clear, the focus does not change when the scene changes



Figure 2-4 Set Focus Mode as Semi-Auto

If the image effect is unsatisfactory, check whether the installation angle is less than 30° and the installation height allows for a complete observation from vehicle. Then you can check and adjust the image settings accordingly.

Scene

Go to **Image** → **Display Settings** → **Scene** and select a scene that provides the better image quality.

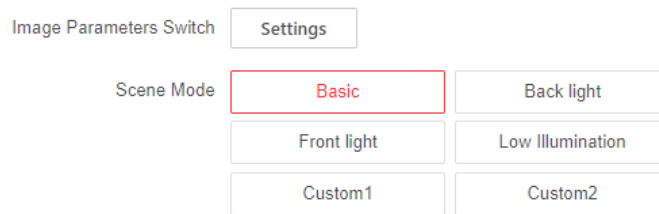

Figure 2-5 Select a Scene with Better Image Quality

Backlight Settings

WDR and HLC might lead to "ghostly" effect and detail loss. If the strong light can be solved by the exposure and gain settings, we recommend you not to enable **WDR** and **HLC**.

Go to **Image** → **Display Settings** → **Backlight Settings** and set **WDR** and **HLC** as **OFF**.



Figure 2-6 Turn Off WDR and HLC

2.2 How to Configure Road Traffic Function?

Vehicle Detection and Mixed-Traffic Detection are available for the road traffic monitoring and license plate recognition. The device captures the passing motor vehicles and non-motor vehicles and uploads the relevant information together with the captured pictures.

Before You Start

- Make sure the device is installed properly. Refer to ***Installation Recommendation*** for details.
- Make sure the image parameters are properly configured. Refer to ***How to Configure Image Parameters to Ensure Clear Imaging for the ANPR Camera?*** for details.
- Make sure the captured license plate picture is clear enough. Refer to ***What Are the Imaging Requirements for License Plate Captures?*** for details.

ANPR Camera Frequently Asked Questions

Note

- This part includes the basic operation of the road traffic function. For more operations, refer to *User Manual* for details.
- The function varies according to different device models. Refer to the actual interface for specific operations.

Steps

1. For certain device models, go to **VCA** to enable **Road Traffic**.
2. Go to **Road Traffic** → **Detection Configuration** (Web Version: 4.x) or **Road Traffic** → **Rule** (Web Version: 5.x) and select the detection type.

- Vehicle Detection** The vehicles that enter the set lane can be detected and the picture of the vehicle and its license plate can be captured and stored. Alarms will be triggered and captures can be uploaded.
- Mixed-Traffic Detection** The motor vehicles and non-motor vehicles that enter the set lane can be detected, and the picture of targets can be captured and stored. Alarms will be triggered and captures can be uploaded.

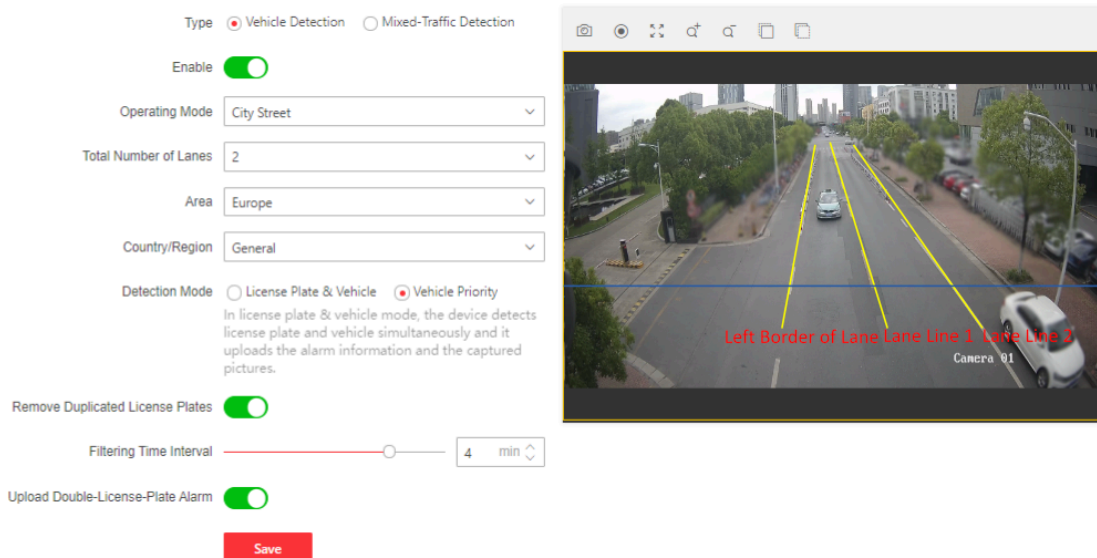

Figure 2-7 Detection Configuration

3. Select the operating mode and the total number of lanes.

Entrance/Exit

The license plate information of the detected vehicle will be uploaded when the vehicle passes the detection area and triggers the detection in the entrance/exit.

City Street

The license plate information of the detected vehicle will be uploaded when the vehicle passes the detection area and triggers the detection in the city street.

Alarm Input

It means the input alarm will trigger a license plate capture and recognition action.

Note

- When **Alarm Input** is selected, the alarm input A<-1 will automatically be assigned to trigger vehicle detection and its alarm type is always NO.
 - If the A<-1 alarm input is used to trigger vehicle detection, it cannot be used for other basic events.
 - When **Alarm Input** is selected and saved, previously configured linkage method for A<-1 will be canceled.
-

4. Click and drag the lane line to set its position, or click and drag the line end to adjust the length and angle of the line.

The blue detection line is the trigger line of the license plate, which is mainly used in the **Entrance/Exit** scene to improve the capture efficiency. It is recommended to put it in the lower middle of the screen to make sure that the full-size car with the plate can pass it.

5. Adjust the zoom ratio of the camera so that the vehicle in the image is clear.
-

Note

Only 1 license plate can be captured at one time for each lane.

6. **Optional:** Check to select **License Plate Category**.

In certain countries/regions, the license plate number includes the license plate category and the license plate main number. This function is used to configure whether the license plate category is included in the license plate number.

- If the function is not enabled, only the license plate main number is displayed in the license plate number.
 - When this function is enabled, the license plate category is included in the license plate number.
-

Note

This function is only supported in certain countries/regions.

7. Set the detection mode.

Vehicle Priority

The device will detect the vehicle scale first, then catch the plate out to make the analysis. It will get the better accuracy but sometimes it will lose some results in the not-satisfied installation scenario.

License Plate & Vehicle

In license plate & vehicle mode, the device detects license plate and vehicle simultaneously and it uploads the alarm information and the captured pictures.

Note

It is recommended to select **Vehicle Priority** mode if there are no issues on installation and supplement light. After the issues of plate recognition are carried out, you can switch the mode to **License Plate & Vehicle** mode.

8. Check **Remove Duplicated License Plates** and set the **Time Interval**. The default time interval is 4 minutes. Refer to [How to Filter the Duplicated License Plates?](#) for details.



Figure 2-8 Remove Duplicated License Plates

9. **Optional:** Check to enable **Upload Motorcycle Alarm**, and the device uploads the both motor vehicle and non-motor vehicle (i.e., motorcycle) alarm information, otherwise it uploads only the motor vehicle alarm information.

Note

This function is only supported in **Entrance/Exit** mode.

10. **Optional:** Check to enable **Upload Double-License-Plate Alarm**, and the device can detect and recognize two license plates in one vehicle and upload the alarm.
 - When **Upload Double-License-Plate Alarm** is enabled, **Remove Duplicated License Plates** and **Wiegand Linkage** is only available for the primary license plate.
 - When **Upload Double-License-Plate Alarm** is enabled, the blacklist and allowlist is distinguished only for the primary license plate. If the secondary license plate is recognized but not the primary license plate, the blacklist and allowlist are not available, and the linkage will be performed according to the setting of **Other List**.
 - When two license plates in one vehicle are recognized, if the license plate number is set to be overlaid, both license plate numbers can be overlaid, and the license plate picture can be captured and uploaded. License plate number, license plate close-up picture of both primary and secondary license plates can be displayed in **Smart Display**.

Note

This function is not supported in **License Plate & Vehicle** mode.

11. Go to **Arming Schedule and Linkage Method**. You can set the arming schedule and linkage method independently for blacklist, allowlist and other list, and you should set them one by one.

The screenshot shows a configuration interface for an ANPR camera. At the top, there are three buttons for 'Target Type': 'Blocklist' (highlighted with a red border), 'Allowlist', and 'Others'. Below this is the 'Arming Schedule' section with an 'Arming Schedule' label and an 'Edit' button. The 'Linkage Method' section includes a 'Direction' section with three radio buttons: 'All' (selected), 'Forward', and 'Reverse'. There are three toggle switches: 'Send Email' (disabled), 'Notify Surveillance ...' (enabled), and 'Upload to FTP/Mem...' (enabled). A 'Trigger Alarm Output' section has a 'Select All' checkbox checked and a list of checkboxes for 'A->1' and 'A->2', both of which are checked. At the bottom, there are two buttons: a red 'Save' button and a 'Copy to...' button.

Figure 2-9 Arming Schedule and Linkage Method

- 1) Click to select the blocklist, allowlist and other list.
- 2) Set the arming schedule.
- 3) Set the linkage method. Check the checkbox of corresponding linkage method for each rule, and click **Save** to save the settings.

Direction

Only the vehicles moving as the selected direction can trigger the selected linkage methods.

All

All means that the vehicles in all moving directions will be considered. It is highly recommended to choose **All** if there is no special use.

Forward

Forward means that the vehicle moves toward the camera.

Reverse

Reverse means that the vehicle moves away from the camera.

The linkage will be triggered only when the detected vehicle driving direction is the same as the configured direction.

12. Go to **Road Traffic → Picture** (Web Version: 4.x) or **Road Traffic → Overlay & Capture** (Web Version: 5.x) to set the image parameters and text overlay of the captured pictures in vehicle detection and mixed-traffic detection.

ANPR Camera Frequently Asked Questions

Picture Type License Plate/Target Close-up Vehicle Background

Picture Quality

Restriction Type Picture Quality Picture Size

Picture Quality 80

*Picture Size Kb

Picture Resolution

FTP Host

FTP Picture Name Default Custom

Picture Name

Text Overlay

Text Overlay

Font Color

Background Color

Text Overlay

Text Overlay

Type Type | Sort

Figure 2-10 Overlay & Capture Picture Settings

13. Import or export the blocklist and allowlist file. If you do not have such a list in advance, click **Export** and export the template first to make one. Browse to the file and import it.

List + Add Import Batch Delete Export All Clear

No.	License Plate No.	Type	Creation Time	Effective Start Date	Effective End Date	Operation
1						<input type="checkbox"/> <input type="checkbox"/>
2						<input type="checkbox"/> <input type="checkbox"/>

Figure 2-11 Import or Export Blocklist & Allowlist

Example

The list template example is as follow.

Note

It is recommended to enter the plate number as consecutive digits/letters without spaces.

A	B	C	D	E
No.	Plate No.	Group(0 block list, 1 allow list)	Effective Start Date (Format: YYYY-MM-DD)	Effective End Date (Format: YYYY-MM-DD)

Figure 2-12 Blocklist & Allowlist Template

2.3 How to Configure Wiegand?

Question

How to configure Wiegand?

Answer

For Wiegand wiring, refer to the Wiegand documentation and the *Quick Start Guide* of the device for details.

Go to **Configuration** → **System** → **System Settings** → **Wiegand** . Check **Enable** and select the **Protocol**. The default protocol is **SHA-1 26bit**. If enabled, the recognized license plate number will be output via the selected Wiegand protocol.

Note

Only certain device models support Wiegand interface. Refer to the device specifications for details.

Example

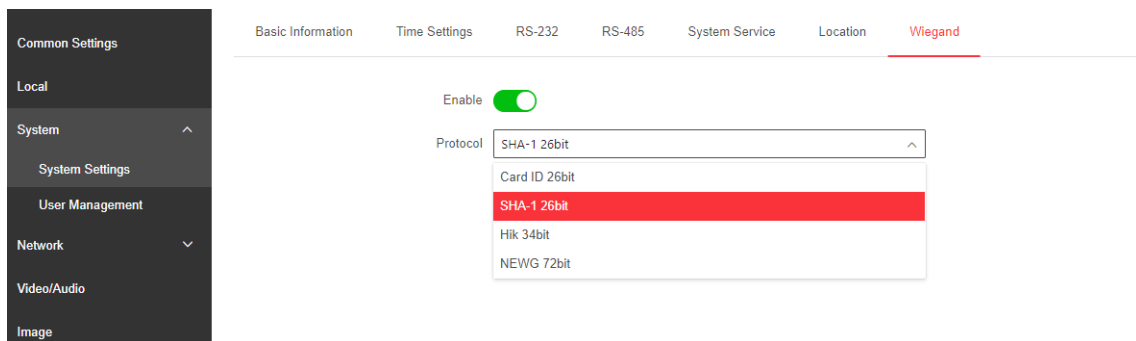

Figure 2-13 Configure the Wiegand protocol

2.4 How to Filter the Duplicated License Plates?

Question

How to filter the duplicated license plates?

Answer

This function is implemented by the algorithm.

Go to the detection configuration rule setting interface to enable **Remove Duplicated License Plates** and set **Time Interval**.

Example

In the following picture, the **Time Interval** is set as **4**, which indicates that the device supports 0 to 4 minutes of the same license plate filtering configuration.



Figure 2-14 Remove Duplicated License Plates

2.5 Why Cannot I Import the Blocklist and Allowlist File?

Question

Why cannot I import the blocklist and allowlist file?

Answer

- The blocklist and allowlist file format is incorrect. Check the file format.

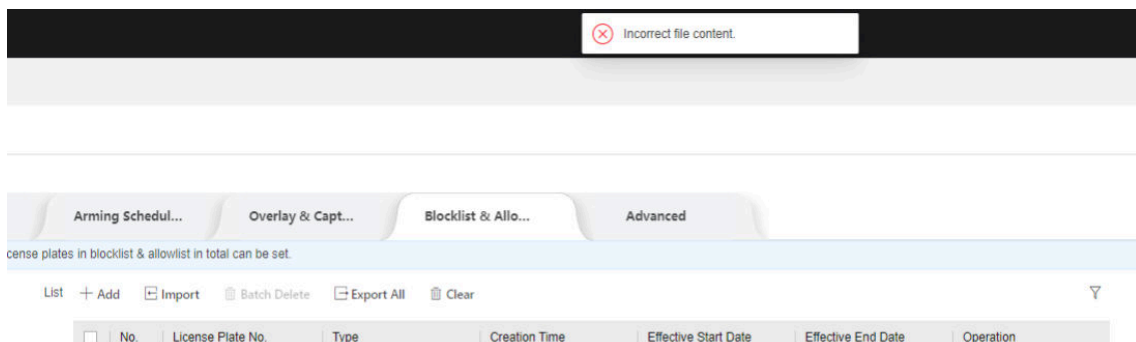

Figure 2-15 Incorrect File Format

- The blocklist and allowlist template is incorrect. The template is preset by the system and cannot be customized. You should export the blocklist and allowlist template from the camera, fill out the license plate information, and import the file. For configuration details, see [How to Configure Road Traffic Function?](#)

ANPR Camera Frequently Asked Questions

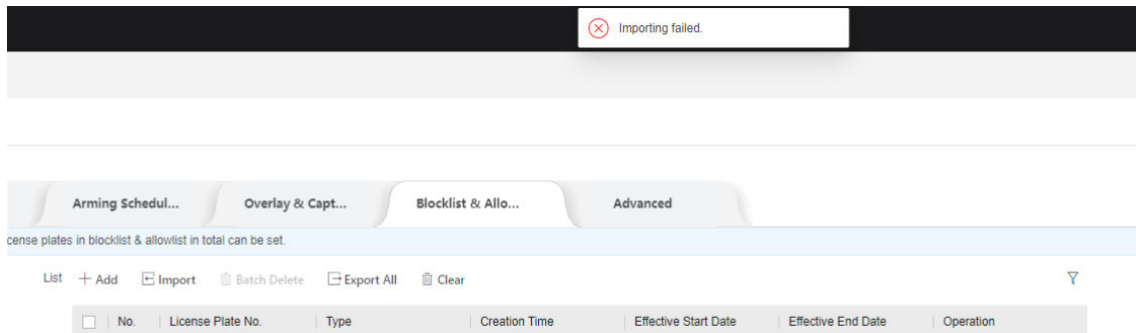

Figure 2-16 Importing Configuration File Failed

2.6 Why Does Not My Completed Linkage Configuration Take Effect?

Example

The screenshot shows a configuration interface for an ANPR camera. It is divided into three main sections: Target Type, Arming Schedule, and Linkage Method. In the Target Type section, there are three buttons: 'Blocklist' (highlighted with a red border), 'Allowlist', and 'Others'. The Arming Schedule section has a label 'Arming Schedule' and an 'Edit' button. The Linkage Method section includes a 'Direction' section with three radio buttons: 'All' (selected), 'Forward', and 'Reverse'. Below this are three toggle switches: 'Send Email' (disabled), 'Notify Surveillance ...' (enabled), and 'Upload to FTP/Mem...' (enabled). The 'Trigger Alarm Output' section has a 'Select All' checkbox (checked) and a list of two items: 'A->1' and 'A->2', both with checked checkboxes. At the bottom, there are two buttons: a red 'Save' button and a grey 'Copy to...' button.

Figure 2-17 Configuration of Arming Schedule and Linkage Method

Question

Why does not my completed linkage configuration take effect?

Answer

Confirm whether the arming schedule and linkage methods of the allowlist, blocklist, and other lists are configured. If you have completed the configuration, check the wiring of the barrier and the camera.

2.7 What Are the Imaging Requirements for License Plate Captures?

Question

What are the imaging requirements for license plate captures?

Answer

- The license plate in the field of view shall be clear and discernible without motion blur.
- The size of the license plate shall be moderate, neither too large nor too small, to avoid blurred characters and overexposure.
- The height of main field characters is recommended to be between 20 and 40 pixels. You can use the drawing software on Windows to check the pixels of the characters.
- If it is necessary to recognize the subfield simultaneously, ensure that the height of the subfield characters is at least 16 pixels.



Figure 2-18 Main Field and Subfield Characters

- For license plates with multiple single-line characters, the length of the main field shall not exceed 200 pixels.

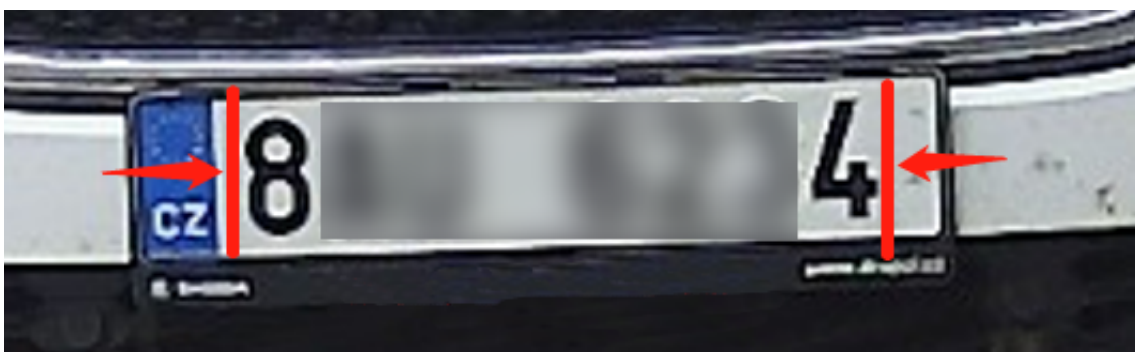

Figure 2-19 Main Field

ANPR Camera Frequently Asked Questions

- The inclination angle is recommended to be within the $\pm 15^\circ$ range. Refer to the following pictures to check the inclination angle. The following pictures are examples for an inclination angle within the $\pm 5^\circ$ range.

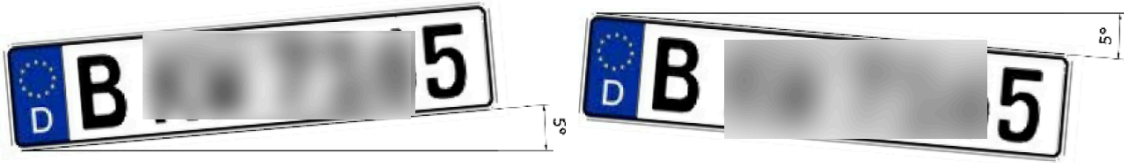

Figure 2-20 Inclination Angle

- The lens shall be in the manual light exposure mode with the best focusing effect.

Chapter 3 License Plate Recognition

3.1 What If the License Plate Recognition Error Occurs?

Question

How to solve the problem when the license plate recognition error occurs, such as missing license plates, incorrectly recognizing the license plate characters, or inaccurately judging the driving direction?

Cause 1

Missing capture.

Table 3-1 The Possible Issues and Solutions for Missing Capture

Issue	Solution
Improper installation.	Adjust the installation height or angle.
Focus too far or too close.	Adjust the focus.
The image is not clear, or the image is overexposed.	Set the image parameters properly. Refer to <i>How to Configure Image Parameters to Ensure Clear Imaging for the ANPR Camera?</i> and the display settings in <i>User Manual</i> for details.
Inappropriate detection parameter settings.	Set the detection parameters properly, especially for the detection mode (Mixed-Traffic, Entrance/Exit, City Street, Alarm Input), snap line, the number of lanes, and license plate recognition area. Refer to <i>How to Configure Road Traffic Function?</i> and the Road Traffic section in <i>User Manual</i> for details.

Cause 2

There is a captured picture, but it is not recognized.

Table 3-2 The Possible Issues and Solutions for Not Recognizing the License Plate When a Captured Picture Exists

Issue	Solution
The pixel size of the captured license plate picture does not meet the requirements.	Refer to <i>What Are the Imaging Requirements for License Plate Captures?</i> to confirm the appropriate requirements for captured picture.

ANPR Camera Frequently Asked Questions

Issue	Solution
	Adjust the installation height, installation angle, gain, shutter, WDR (Wide Dynamic Range), etc.
The license plate image is not clear.	Set the image parameters and adjust the focal length properly. Refer to <i>How to Configure Image Parameters to Ensure Clear Imaging for the ANPR Camera?</i> and the display settings in <i>User Manual</i> for details.
Inappropriate detection parameter settings.	Set the detection parameters properly, especially for the snap line, the number of lanes, and the license plate recognition area. Refer to <i>How to Configure Road Traffic Function?</i> and the Road Traffic section in <i>User Manual</i> for details.

Other Solution

If the problem is still cannot be solved by the above ways, please consult our service center or technical support to obtain the further solutions.

3.2 Why Is the Background Dark in the Captured Picture?

Example



Figure 3-1 Dark Background

Question

Why is the background dark in the captured picture?



Answer

The background is too dark, and only the license plate is visible. This issue is not related to a product defect, but an existing design mechanism. The priority of an ANPR product is to ensure the license plate recognition with the scene monitoring function as an additional feature.

For the scene where the license plate recognition effect is affected by excessive brightness, the camera will limit the shutter and gain to ensure the recognition quality. With the limited shutter and gain, the captured picture will not be overexposed and the characters on the license plate are clearly visible. Therefore, the background brightness might be affected. The insufficient background brightness in this scene is consistent with the product's specifications.

3.3 Why Is the Captured Picture Incomplete but the Recognized Plate Number Correct?

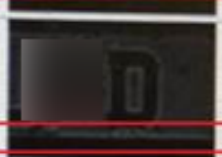
Example

No.	Capture Time	Plate No.	Captured Picture
20	06-11-2018 10:52:38	E 111D	
19	06-11-2018 10:36:07	E 111D	
18	06-11-2018 10:26:04	E 111D	

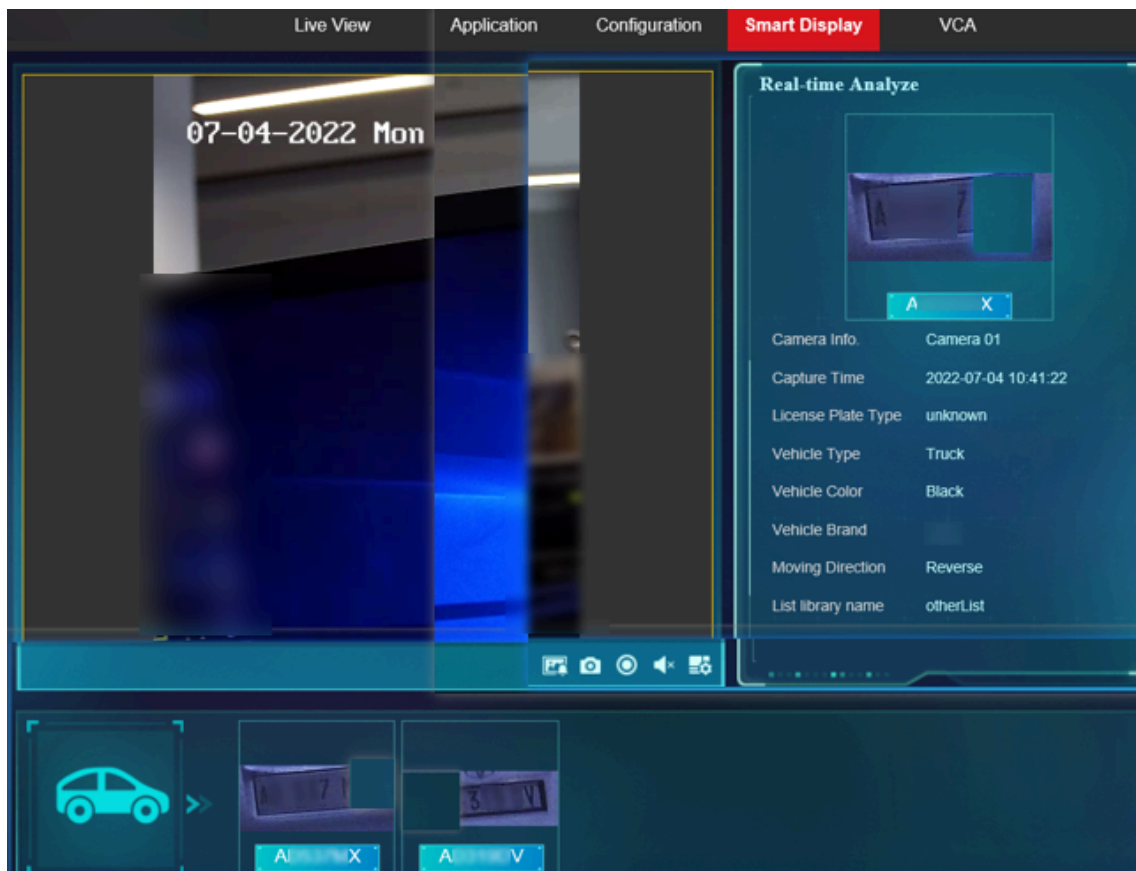

Figure 3-2 Incomplete Captured Picture with Correct Plate Number

Question

Why is the captured picture incomplete but the recognized license plate number correct?

Answer

Check if the captured license plate picture meets the imaging requirements. For imaging requirements, refer to ***What Are the Imaging Requirements for License Plate Captures?***. Check the installation of the camera and its configuration. In the large picture of the vehicle, configure the parameters of the character parts of the license plate. If the problem remains, provide POS videos and POS pictures for analysis.

Chapter 4 Scenario Cases

4.1 Inappropriate Scenarios

4.1.1 Large Deflection Angle

Installation scenarios with a large deflection angle or depression angle greater than 30° are not recommended. It might lead to recognition failures due to an unstable vehicle attitude.

- As the vehicle approaches a horizontal position with the camera, the effectiveness of the vehicle detection decreases, resulting in discontinuous tracking and false captures.
- The large deflection and depression angle makes the camera difficult to obtain consistent and accurate recognition results for the license plates along the driving path.
- The non-standard entrance and exit scene with poor vehicle attitude might lead to incorrect judgments on the vehicles' attributes including the type, brand, and color.

4.1.2 Open Scene

When there is no clear lane line, and the vehicle driving direction is arbitrary or even conflicting, one camera undertakes the task of multiple cameras.

Vehicles with multiple directions in a scene will cause the following problems:

- The large vehicle deflection angle may cause poor vehicle detection effect and affects the vehicle attribute recognition or vehicle capture.
- The side of the vehicle body drives at a large angle, which is easy to make mistakes.
- The license plate recognition area is not easy to be set, and the license plate may be incomplete.
- The characters on the side of the vehicle body are easily misidentified.

4.1.3 Far from the Target

If the camera is too far from the vehicle or its license plate, the size of the license plate might not meet the imaging requirements. The minimum height of the characters on the license plate is 16 pixels.

4.1.4 Far Behind the Barrier

For installation scenarios with an entrance or an exit, if the camera is far behind the barrier, it cannot effectively recognize the license plate and send signals to raise the barrier.

When the vehicle stops in front of the pole, the license plate is still in the detection area. In this case, the algorithm judges that the license plate does not leave the detection area, and the camera will not send the upload signal. Therefore, the barrier remains in a lowered position.

Camera installation improvement: The camera at the entrance and exit should be positioned at or in front of the barrier. To ensure effective coverage, mount the camera at a height over 1.5 meters with a certain depression angle.

4.2 Not Recommended Scenarios

4.2.1 The Vehicle Body Is Not Fully Exposed

In this scenario, the license plate recognition function may be available, but the effect of vehicle type and other attributes recognition is poor. Since the driving direction of the vehicle is fixed, the license plate recognition can be performed. However, the body cannot be fully exposed. In this case, if it is necessary to recognize the vehicle type, the non-fully-exposed vehicle body scenario may not meet the condition.

The vehicle body snapshot is incomplete, making it is impossible to recognize vehicle attributes.

4.2.2 Uncontrollable Driving Directions

For installation scenarios with changeable lanes, the vehicle often change its directions. Uncontrollable driving directions might lead to recognition failures.

- When the driving direction is uncontrollable, it is difficult for the camera to obtain complete recognition results.
- When the driving direction is uncontrollable, it might lead to incorrect judgments on license plate information.

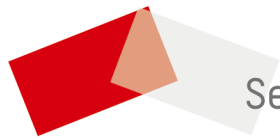

See Far, Go Further